

VL4 Bracket Mount







VL4 Bracket Mount

PRODUCT INFORMATION:

The mid-range offering of the VL series, the VL4 has a streamline design for machines with 12-48 volt systems offering up to 825 effective lumen lights with 4 LED's. The VL4 is available with a thru bolt mount or a bracket mount to easily tilt the light to shine light where it is needed and has alternative coloured LED options in white, green or red.



-  EMC TESTED
-  IP 69K
-  VIBRATION TESTED
-  SALT SPRAY TESTED
-  UL RATED OPTIONAL

Operating Temp: -40° to 75°C
-40° to 85°C

Light Pattern: Symmetric,
Asymmetric

Lens Material: Plastic

Housing: Cast Aluminium

Mounting Options:
Thru Bolt

Connector: (DT04-2P) Built in

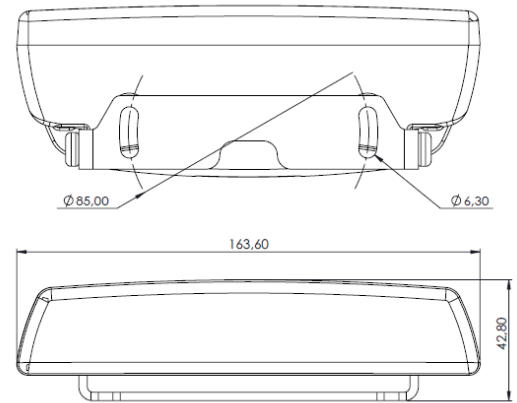

LIGHT BEAM PATTERNS:

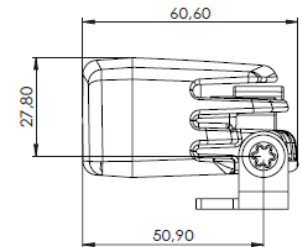
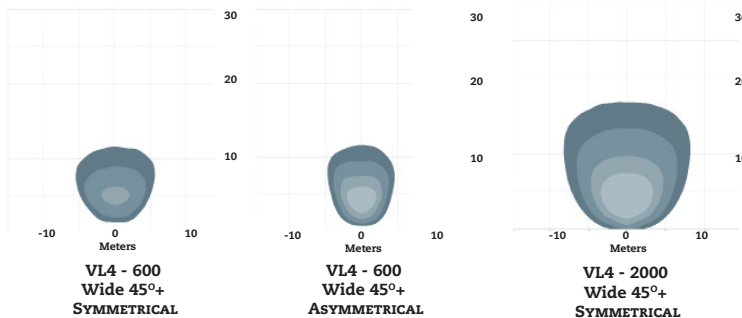

LUMEN OUTPUT		Number of LED'S	VOLTAGE		AMP DRAW		Power (Watts)	Colour Temp	CRI	EMC EN55025 CLASS	IP 69K	Vibration 5-2000Hz 3 Axis	Salt Spray ASTMB117	UL Rated Optional
Theoretical	Effective		Machine	Operating Range	12 Volts	24 Volts								
900	600	4	12-48	9 60	1.2 0.6	15	5700	70	4	●	10 Grms	●	●	
1100	825	4	12-48	9 60	1.2 0.6	15	5700	75	4	●	10 Grms	●	●	
2600	2000	4	12-48	9 60	1.8 0.9	22	5700	70	3	●	10 Grms	●		
2600	2000	4	12	9 16	1.8	22	5700	70	5	●	10 Grms	●		
2600	2000	4	24	18 32	0.9	22	5700	70	5	●	10 Grms	●		